

# MEDICAL

# WHEELS





## THE COMPANY

EMES A.S. was established as a multi-partner firm in 1998 by well-known traders who have been doing business in the world markets. In a short time, the company became a strong trademark and made an appearance both in domestic and foreign markets. It has attained a high quality in the production and increased the standard product kinds to more than 9.000 to date. This way, the company became more competitive not only country-wide but also Worldwide. EMES A.S., with its dynamic and self-renewing nature has determined its vision to be the most preferred and reliable trademark globally, and to export mostly to the European countries and subsequently to more than 67 countries of Middle East, Africa, Balkans and Middle Asia.

EMES A.S. works taking into consideration the principle of “**absolute customer satisfaction**” which is part of the quality policy of the company thanks to its well-trained technical staff in a modern facility of 10.000 sqm<sup>2</sup> covered area. The company has arranged a special human resource with a highly creative team by maintaining an internationally recognised quality standart. It is the first company in Turkey which has the Certificate of **DIN EN ISO 9001:2015**. Our mission is to offer more reliable, high quality and aesthetic designed products to our costumers, and to follow the developments and innovations in the sector for making them part of our quality policy. We strive to provide our domestic and international customers with the best products and services which reflect the “**Made in Turkiye**” quality, and help them find the most suitable solutions for their needs.



# PRODUCT CODING SYSTEM



## FITTING TYPES



### Plate Fitting:

Plate fitting is generally used for light duty, transport equipment and heavy duty castors. The castors are fitted to any equipment with a flat base by means of bolts and nuts

**The following specifications have to be considered when selecting plate fitting:** plate size, hole spacing, hole diameter



### Stem Fitting:

Stem fitting is generally used for light duty and transport equipment castors. These castors are fitted by means of a plug-in

**The following specifications have to be considered when selecting stem fitting:** stem diameter, stem length



### Bolt Hole Fitting:

Bolt hole fitting is generally used for light duty and transport equipment castors. Bolt hole fitting, a connection element is pushed through the bolt of the swivel head

**The following specifications have to be considered when selecting bolt hole fitting:** hole diameter



### Bolt Fitting:

Bolt fitting is generally used for light duty castors. These castors are fitted to the transport unit by means of a threaded pin which is tightened to thread or cylindrical hole and a nut

**The following specifications have to be considered when selecting bolt fitting:** screw diameter, screw length













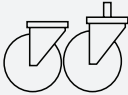







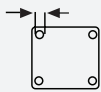

### Expander Fitting:

Expander fitting is generally used for light duty castors. The castor is fitted by means of a synthetic expander which is inserted in to a hole or a round square tube

**The following specifications have to be considered when selecting expander fitting:** tube shape (round or square), internal tube diameter

## Symbols

Symbols in the catalog are shown below

|   |   |   |   |   |
|---|---|---|---|---|
|    |    |    |     |    |
| Product code  | Stem/bolt diameter  | Plate size  | Threadguard   | Fork thickness  |
|  |  |  |  |  |
| Wheel diameter  | Hole diameter   | Plate hole diameter   | Bearing   | Load capacity   |
|  |  |  |  |  |
| Wheel width   | Stem/bolt length  | Plate hole diameter   | Wheel weight  | Axle bore diameter  |
|  |  |  |   |  |
| Offset  | Plate thickness   | Hub length  | Total weight  | Steel thickness   |

(-): Without threadguard

(+): Optional

(S): Standard

All length : (mm)

Product weight : (gr)

Load capacity : (kg)

## Wheel Bearing Types



### Ball Bearing

The ball bearing is generally used for heavy duty castors and transport ball bearing equipment castors. It is resistant to shocks, easy and silent rolling. It has the smallest bearing play, lubricated with long-life grease and is maintenance-free under standard conditions. In addition to the standard type ball bearing is also available in stainless steel type.



### Roller Bearing

The roller bearing is generally used for light duty castors and short distances transport equipment. It is resistant to shocks, strong, lubricated with long-life grease and is maintenance-free under standard conditions. In addition to the standard type roller bearing is also available in stainless steel type.



### Plain Bore Bearing

The plain ball bearing is generally used for light duty castors, and short distances transport equipment. It is resistant to shocks and water. It is a simple, durable wheel, maintenance-free under standard conditions and cost-effective bearing.



### **Determine the required load capacity**

The required load capacity of a wheel or castor is calculated from the weight of the unit and its maximum load, divided by the number of wheels or castors used.

#### **Appropriate castor**

Load capacity with the necessary load capacity can be found by using the formula below.

$$C = \frac{E+L}{N} \times S$$

- C: Minimum load capacity of the castor
- E: Weight of the unit (tare)
- L: Maximum load
- N: Number of wheels or castor used
- S: Safety factor (1,5<E<2,0)



A much more simple method to obtain the minimum load capacity can be applied by dividing the weight of the loaded device to one less of the number of castors. For this purpose the following formula can be used.

$$C = \frac{\text{Total weight}}{\text{Number of castors}-1}$$

### **Select the required wheel bearing type**

To select a suitable bearing, the load, speed, environmental influences and the amount of force need to bring the transport unit into motion need to be considered.

## ECH SERIES



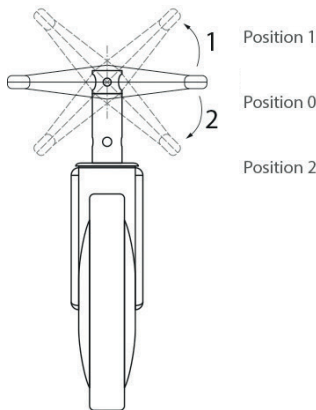



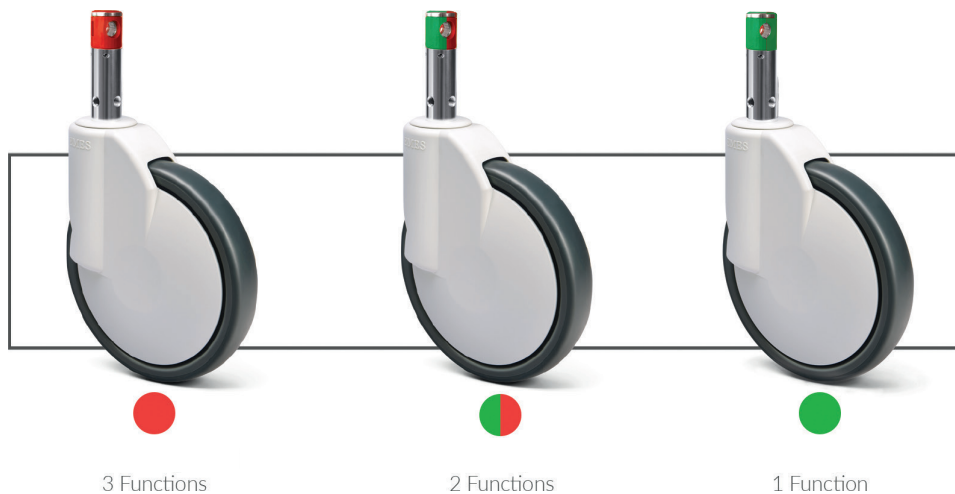

-  Load capacity 150 Kg
-  **Bracket:** Zinc-coated spherical tongs made of sheet steel. Side and top covers made of impact resistant high performance plastic
-  **Wheel:** Thermoplastic coated wheel with polypropylene rim resistant to uneven ground



|            | 3 Functions      |        |             | 2 Functions      |        |             | 1 Function       |        |             |
|------------|------------------|--------|-------------|------------------|--------|-------------|------------------|--------|-------------|
|            | Directional Lock | Swivel | Castor Lock | Directional Lock | Swivel | Castor Lock | Directional Lock | Swivel | Castor Lock |
| Position 1 | +                |        |             |                  | +      |             |                  | +      |             |
| Position 0 |                  | +      |             |                  | +      |             |                  | +      |             |
| Position 2 | +                |        | +           | +                |        | +           |                  | +      |             |













| Swivel Castor/Brake |  mm |  mm |  mm |  mm |  mm |  mm |  mm |  gr |  kg |
|---------------------|--|--|--|--|--|--|--|--|--|
| ECH 03 MBT 125 F    | 125  | 32   | 159  | 32   | 50   | 40   | 2,5  | 992  | 150  |
| ECH 03 MBT 150 F    | 150  | 32   | 183  | 32   | 50   | 38   | 2,5  | 1135   | 150  |
| ECH 03 ZBP 200 F    | 200  | 32   | 226  | 32   | 50   | 60   | 3  | 1427   | 150  |









● Central Lock



| Swivel Castor/Brake |  mm |  mm |  mm |  mm |  mm |  mm |  mm |  gr |  kg |
|---------------------|--|--|--|--|--|--|--|--|--|
| ECH 03 MBT 125 F    | 125  | 32   | 159  | 32   | 50   | 40   | 2,5  | 992  | 150  |
| ECH 03 MBT 150 F    | 150  | 32   | 183  | 32   | 50   | 38   | 2,5  | 1135   | 150  |
| ECH 03 ZBP 200 F    | 200  | 32   | 226  | 32   | 50   | 60   | 3  | 1427   | 150  |









● Directional & Central Lock



| Swivel Castor  |  mm |  mm |  mm |  mm |  mm |  mm |  mm |  gr |  kg |
|----------------|--|--|--|--|--|--|--|--|--|
| ECH 03 MBT 125 | 125  | 32   | 159  | 28   | 41   | 40   | 2,5  | 980  | 150  |
| ECH 03 MBT 150 | 150  | 32   | 183  | 28   | 41   | 38   | 2,5  | 1122   | 150  |
| ECH 03 ZBP 200 | 200  | 32   | 226  | 28   | 41   | 60   | 3  | 1408   | 150  |









● Swivel without brake



| Swivel Castor/Brake |  mm |  mm |  mm |  mm |  mm |  mm |  mm |  gr |  kg |
|---------------------|--|--|--|--|--|--|--|--|--|
| ECH 03 MBT 125 F    | 125  | 32   | 159  | 28   | 94   | 40   | 2,5  | 1080   | 150  |
| ECH 03 MBT 150 F    | 150  | 32   | 183  | 28   | 94   | 38   | 2,5  | 1225   | 150  |
| ECH 03 ZBP 200 F    | 200  | 32   | 226  | 28   | 94   | 60   | 3  | 1537   | 150  |

● Directional & Central Lock





| Swivel Castor/Brake |  mm |  mm |  mm |  mm |  mm |  mm |  mm |  gr |  kg |
|---------------------|--|--|--|--|--|--|--|--|--|
| ECH 03 MBT 125 F    | 125  | 32   | 159  | 28   | 94   | 40   | 2,5  | 1080   | 150  |
| ECH 03 MBT 150 F    | 150  | 32   | 183  | 28   | 94   | 38   | 2,5  | 1225   | 150  |
| ECH 03 ZBP 200 F    | 200  | 32   | 226  | 28   | 94   | 60   | 3  | 1537   | 150  |

● Central Lock

## EC SERIES









 Load Capacity 90 Kg

 **Bracket:** Bracket made of plastic, gray (RAL 9002) double ball bearing swivel head, wheel axle with riveted









 **Wheel:** Wheel centre made of polypropylene, thermoplastic rubber tread, plastic threadguards, ball bearing

 **Fitting Type:** Plate, stem, bolt hole, bolt, expander fitting types







| Swivel Castor |  mm |  mm |  mm |  mm |  mm |  mm |  gr |  kg |  |
|---------------|--|--|--|--|--|--|--|--|---|
| EC 01 MBT 100 | 100  | 32   | 138  | 78x68  | 56x46  | 5,7  | 538  | 80   | S   |
| EC 01 MBT 125 | 125  | 32   | 165  | 78x68  | 56x46  | 7,5  | 764  | 90   | S   |











| Swivel Castor/Brake |  mm |  mm |  mm |  mm |  mm |  mm |  gr |  kg |  |
|---------------------|--|--|--|--|--|--|--|--|---|
| EC 01 MBT 100 F     | 100  | 32   | 138  | 78x68  | 56x46  | 5,7  | 586  | 80   | S   |
| EC 01 MBT 125 F     | 125  | 32   | 165  | 78x68  | 56x46  | 7,5  | 816  | 90   | S   |









## ESP SERIES

-  **Load Capacity** 90 Kg
-  **Bracket:** Centre made of plastic, gray or black colour options (RAL 9002), double ball bearing swivel head wheel axle with riveted
-  **Wheel:** Centre made of polypropylene, thermoplastic rubber option, plastic threadguard, ball bearing type
-  **Fitting Type:** Plate, hole fitting types











| Swivel Castor  |  mm |  mm |  mm |  mm |  mm |  mm |  gr |  kg |  |
|----------------|--|--|--|--|--|--|--|--|---|
| ESP 01 MBT 100 | 100  | 32   | 140  | 68x78  | 46x56  | 7  | 547  | 90   | S   |
| ESP 01 MBT 125 | 125  | 32   | 169  | 68x78  | 46x56  | 7  | 658  | 100  | S   |











| Swivel Castor/Brake |  mm |  mm |  mm |  mm |  mm |  mm |  gr |  kg |  |
|---------------------|--|--|--|--|--|--|--|--|---|
| ESP 01 MBT 100 F    | 100  | 32   | 140  | 68x78  | 46x56  | 7  | 581  | 90   | S   |
| ESP 01 MBT 125 F    | 125  | 32   | 169  | 68x78  | 46x56  | 7  | 696  | 100  | S   |









| Swivel Castor  |  mm |  mm |  mm |  mm |  mm |  mm |  gr |  kg |  |
|----------------|--|--|--|--|--|--|--|--|---|
| ESP 03 MBT 100 | 100  | 32   | 137  | 22   | 42   | 7  | 574  | 90   | S   |
| ESP 03 MBT 125 | 125  | 32   | 167  | 22   | 50   | 7  | 680  | 100  | S   |









| Swivel Castor/Brake |  mm |  mm |  mm |  mm |  mm |  mm |  gr |  kg |  |
|---------------------|--|--|--|--|--|--|--|--|---|
| ESP 03 MBT 100 F    | 100  | 32   | 137  | 22   | 42   | 7  | 608  | 90   | S   |
| ESP 03 MBT 125 F    | 125  | 32   | 167  | 22   | 50   | 7  | 723  | 100  | S   |











| Swivel Castor  |  mm |  mm |  mm |  mm |  gr |  kg |  |
|----------------|--|--|--|---|--|--|---|
| ESP 04 MBT 100 | 100  | 32   | 137  | 10-12   | 409  | 90   | S   |
| ESP 04 MBT 125 | 125  | 32   | 166  | 10-12   | 525  | 100  | S   |











| Swivel Castor/Brake |  mm |  mm |  mm |  mm |  gr |  kg |  |
|---------------------|--|--|--|---|--|--|---|
| ESP 04 MBT 100 F    | 100  | 32   | 137  | 10-12   | 443  | 90   | S   |
| ESP 04 MBT 125 F    | 125  | 32   | 166  | 10-12   | 563  | 100  | S   |







| Swivel Castor  |  mm |  mm |  mm |  mm |  mm |  mm |  gr |  kg |  |
|----------------|--|--|--|---|--|--|--|--|---|
| ESP 05 MBT 100 | 100  | 32   | 143  | M16-5/8   | 30   | 7  | 502  | 90   | S   |
| ESP 05 MBT 125 | 125  | 32   | 173  | M16-5/8   | 30   | 7  | 610  | 100  | S   |













| Swivel Castor/Brake |  mm |  mm |  mm |  mm |  mm |  mm |  gr |  kg |  |
|---------------------|--|--|--|---|--|--|--|--|---|
| ESP 05 MBT 100 F    | 100  | 32   | 143  | M16-5/8   | 30   | 7  | 540  | 90   | S   |
| ESP 05 MBT 125 F    | 125  | 32   | 173  | M16-5/8   | 30   | 7  | 651  | 100  | S   |











## EQ SERIES

-  Load capacity 50 Kg
-  **Bracket:** PP core, TPE tread or PA core TPU tread, polypropylene or polyamide core
-  **Wheel:** Wheel centre made of polyamide, thermoplastic polyurethane tread, without threadguards, plain bore bearing
-  **Fitting Type:** Plate and bolt fitting types













| Swivel Castor |  mm |  mm |  mm |  mm |  mm |  mm |  mm |  gr |  kg |  |
|---------------|--|--|--|--|--|--|--|--|--|---|
| EQ 01 ZKP 50  | 50   | 10   | 47   | 50x50  | 38x38  | 68   | 18   | 119  | 40   | -   |
| EQ 01 ZKP 75  | 75   | 10   | 55   | 65x65  | 45x45  | 93   | 22   | 265  | 50   | -   |
| EQ 01 ZBP 100 | 100  | 15   | 64   | 65x65  | 45x45  | 127  | 31   | 525  | 110  | -   |













| Swivel Castor/Brake |  mm |  mm |  mm |  mm |  mm |  mm |  mm |  gr |  kg |  |
|---------------------|--|--|--|--|--|--|--|--|--|---|
| EQ 01 ZKP 50 F      | 50   | 10   | 47   | 50x50  | 38x38  | 68   | 18   | 125  | 40   | -   |
| EQ 01 ZKP 75 F      | 75   | 10   | 55   | 65x65  | 45x45  | 93   | 22   | 279  | 50   | -   |
| EQ 01 ZBP 100 F     | 100  | 15   | 64   | 65x65  | 45x45  | 127  | 31   | 545  | 110  | -   |



| Swivel Castor |  mm |  mm |  mm |  mm |  mm |  mm |  mm |  gr |  kg |  |
|---------------|--|--|--|--|--|--|--|--|--|---|
| EQ 05 ZKP 50  | 50   | 10   | 47   | M8-5/16  | 18   | 63   | 15   | 83   | 40   | -   |
| EQ 05 ZKP 75  | 75   | 10   | 55   | M10-3/8  | 22   | 85   | 15   | 197  | 50   | -   |
| EQ 05 ZBP 100 | 100  | 15   | 64   | M12  | 31   | 120  | 20   | 465  | 110  | -   |





| Swivel Castor/Brake |  mm |  mm |  mm |  mm |  mm |  mm |  mm |  gr |  kg |  |
|---------------------|--|--|--|--|--|--|--|--|--|---|
| EQ 05 ZKP 50 F      | 50   | 10   | 47   | M8-5/16  | 18   | 63   | 15   | 89   | 40   | -   |
| EQ 05 ZKP 75 F      | 75   | 10   | 55   | M10-3/8  | 22   | 85   | 15   | 208  | 50   | -   |
| EQ 05 ZBP 100 F     | 100  | 15   | 64   | M12  | 31   | 120  | 20   | 485  | 110  | -   |

## ER SERIES

 Load Capacity 150 Kg

 **Bracket:** Made of pressed steel, white zinc plated, double ball bearing swivel head, wheel axle with bolt and nut







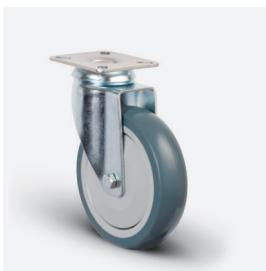
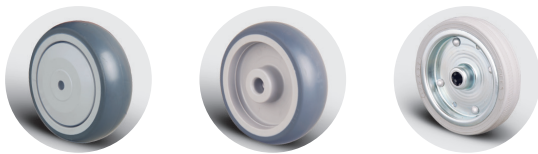

 **Wheel:** centre made of polypropylene, plain bore and ball bearing types, rubber or thermoplastic rubber options

 **Fitting Type:** Plate, fixed, stem bolt hole, bolt expander fitting types











## WHEEL TYPES







| Swivel Castor |  mm |  mm |  mm |  mm |  mm |  mm |  gr |  kg |  |
|---------------|--|--|--|---|--|--|--|--|---|
| ER 01 MBT 80  | 80   | 32   | 114  | 78x68   | 56x46  | 2,5  | 607  | 75   | S   |
| ER 01 MBT 100 | 100  | 32   | 136  | 78x68   | 56x46  | 2,5  | 665  | 80   | S   |
| ER 01 MBT 125 | 125  | 32   | 160  | 78x68   | 56x46  | 2,5  | 775  | 90   | S   |
| ER 01 MBT 150 | 150  | 32   | 183  | 78x68   | 56x46  | 2,5  | 1075   | 110  | S   |
| ER 01 MBT 200 | 200  | 32   | 237  | 78x68   | 56x46  | 2,5  | 1360   | 150  | S   |



| Swivel Castor/Brake |  mm |  mm |  mm |  mm |  mm |  mm |  gr |  kg |  |
|---------------------|--|--|--|---|--|--|--|--|---|
| ER 01 MBT 80 F      | 80   | 32   | 114  | 78x68   | 56x46  | 2,5  | 755  | 75   | S   |
| ER 01 MBT 100 F     | 100  | 32   | 136  | 78x68   | 56x46  | 2,5  | 810  | 80   | S   |
| ER 01 MBT 125 F     | 125  | 32   | 160  | 78x68   | 56x46  | 2,5  | 935  | 90   | S   |
| ER 01 MBT 150 F     | 150  | 32   | 183  | 78x68   | 56x46  | 2,5  | 1184   | 110  | S   |
| ER 01 MBT 200 F     | 200  | 32   | 237  | 78x68   | 56x46  | 2,5  | 1287   | 150  | S   |









## EP SERIES

-  Load capacity 50 Kg
-  **Bracket:** Bracket made of pressed steel, white zinc plated, double ball bearing swivel head, wheel axle with riveted and bolt
-  **Wheel:** Wheel centre made of polyamide, PVC tread without threadguards, plain bore bearing
-  **Fitting Type:** Plate, fixed, stem bolt types











## WHEEL TYPES







| Swivel Castor |  mm |  mm |  mm |  mm |  mm |  mm |  gr |  kg |  |
|---------------|--|--|--|--|--|--|--|--|---|
| EP 01 ZKC 50  | 50   | 20   | 74   | 50x50  | 38x38  | 2  | 218  | 35   | +   |
| EP 01 ZKC 75  | 75   | 25   | 103  | 65x65  | 47x47  | 2  | 340  | 50   | +   |



| Swivel Castor/Brake |  mm |  mm |  mm |  mm |  mm |  mm |  gr |  kg |  |
|---------------------|--|--|--|--|--|--|--|--|---|
| EP 01 ZKC 50 F      | 50   | 20   | 74   | 50x50  | 38x38  | 2  | 245  | 35   | +   |
| EP 01 ZKC 75 F      | 75   | 25   | 103  | 65x65  | 47x47  | 2  | 385  | 50   | +   |









## EU SERIES

-  Load capacity 55 Kg
-  **Bracket:** Bracket made of pressed steel, white zinc plated, double ball bearing swivel head, wheel axle with riveted
-  **Wheel:** Wheel centre made of Polyamide, PVC tread without threadguards, plain bore bearing
-  **Fitting Type:** Plate, fixed, stem bolt types











## WHEEL TYPES







| Swivel Castor |    |  mm |  mm |  mm |  mm |  mm |  mm |  gr |  kg |  |
|---------------|----|--|--|--|---|--|--|--|--|---|
| EU 01 ZKC     | 50 | 50   | 20   | 71   | 60x60   | 46x46  | 2  | 215  | 40   | -   |
| EU 01 ZKC     | 75 | 75   | 25   | 100  | 60x60   | 46x46  | 2  | 291  | 55   | -   |



| Swivel Castor/Brake |      |  mm |  mm |  mm |  mm |  mm |  mm |  gr |  kg |  |
|---------------------|------|--|--|--|---|--|--|--|--|---|
| EU 01 ZKC           | 50 F | 50   | 20   | 71   | 60x60   | 46x46  | 2  | 265  | 40   | -   |
| EU 01 ZKC           | 75 F | 75   | 25   | 100  | 60x60   | 46x46  | 2  | 345  | 55   | -   |









## ET SERIES

-  Load capacity 80 Kg
-  **Bracket:** Bracket made of pressed steel, white zinc plated, double ball bearing swivel head, heel axle with riveted or bolt
-  **Wheel:** Wheel centre made of polyamide, PVC tread without threadguards, plain bore bearing
-  **Fitting Type:** Plate, fixed, stem bolt types











## WHEEL TYPES







| Swivel Castor |  mm |  mm |  mm |  mm |  mm |  mm |  gr |  kg |  |
|---------------|--|--|--|--|--|--|--|--|---|
| ET 01 ZKC 50  | 50   | 2x20   | 77   | 65x65  | 47x47  | 2  | 313  | 55   | -   |
| ET 01 ZKC 75  | 75   | 2x25   | 101  | 78x68  | 56x46  | 2,5  | 610  | 80   | +   |



| Swivel Castor/Brake |  mm |  mm |  mm |  mm |  mm |  mm |  gr |  kg |  |
|---------------------|--|--|--|--|--|--|--|--|---|
| ET 01 ZKC 50 F      | 50   | 2x20   | 77   | 65x65  | 47x47  | 2  | 369  | 55   | -   |
| ET 01 ZKC 75 F      | 75   | 2x25   | 101  | 78x68  | 56x46  | 2,5  | 655  | 80   | +   |









## EF SERIES

-  Load Capacity 55 Kg
-  **Bracket:** Bracket made of pressed steel, chromium plating, double ball bearing swivel head, wheel axle with riveted
-  **Wheel:** Wheel centre made of Polypropylene, PVC tread, plain bore bearing
-  **Fitting Type:** Plate and bolt fitting types











## WHEEL TYPES



| Swivel Castor |  mm |  mm |  mm |  mm |  mm |  mm |  gr |  kg |  |
|---------------|--|--|--|--|--|--|--|--|---|
| EF 01 MKC 40  | 40   | 35   | 56   | 42x40  | 30x28  | 1,5  | 141  | 40   | -   |
| EF 01 MKC 50  | 50   | 45   | 73   | 50x50  | 38x38  | 2  | 276  | 55   | -   |



| Swivel Castor |  mm |  mm |  mm |  mm |  mm |  mm |  gr |  kg |  |
|---------------|--|--|--|--|--|--|--|--|---|
| EF 05 MKC 40  | 40   | 35   | 61   | M10 - 3/8  | 16   | 1,5  | 140  | 40   | -   |
| EF 05 MKC 50  | 50   | 45   | 77   | M10 - 3/8  | 16   | 2  | 249  | 55   | -   |





Emes Endüstriyel Makine  
Ekipmanları San. Ve Tic. A.Ş

+90 216 304 06 79



+90 216 309 91 48



info@emesteker.com



www.emesteker.com



Orta Mah. 30 Agustos Cad. No:61 34956 Orhanlı-Tuzla, Istanbul/Turkey